

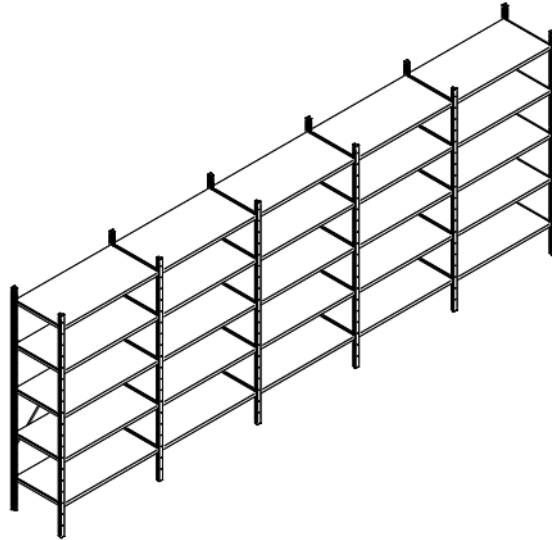

montage handleiding

BT metalen legbordstellingen

BT Metalen Legbordstelling





Stijl

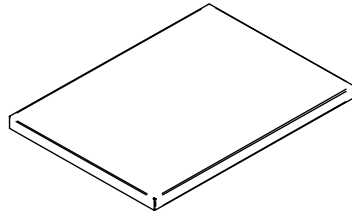

Legbord

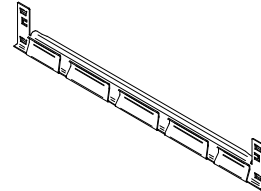

Drager

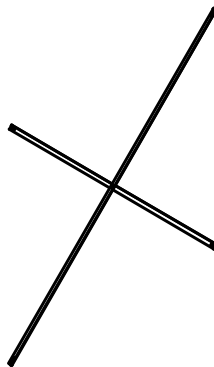

Kruisschoor (standaard)

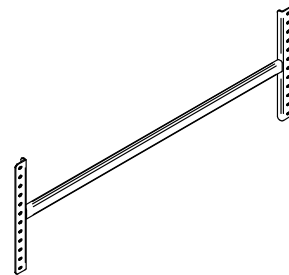

H-schoor (alternatief in plaats van kruisschoor)

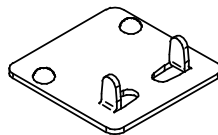

Voetplaat enkel (optie)

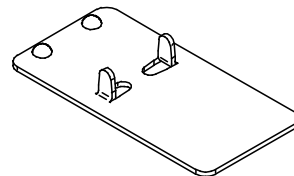

Voetplaat dubbel (optie)

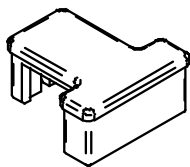

Topdop

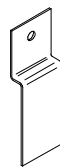

Muurbeugel (optie)

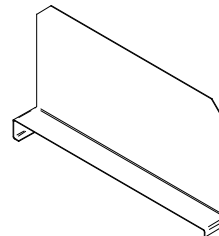

Schuifshot (optie)

Benodigd gereedschap

- Rubber hamer



- Schroevendraaier (kruiskop)



- Ratel + dop (7)



- Inbussleutel (3)



1



2

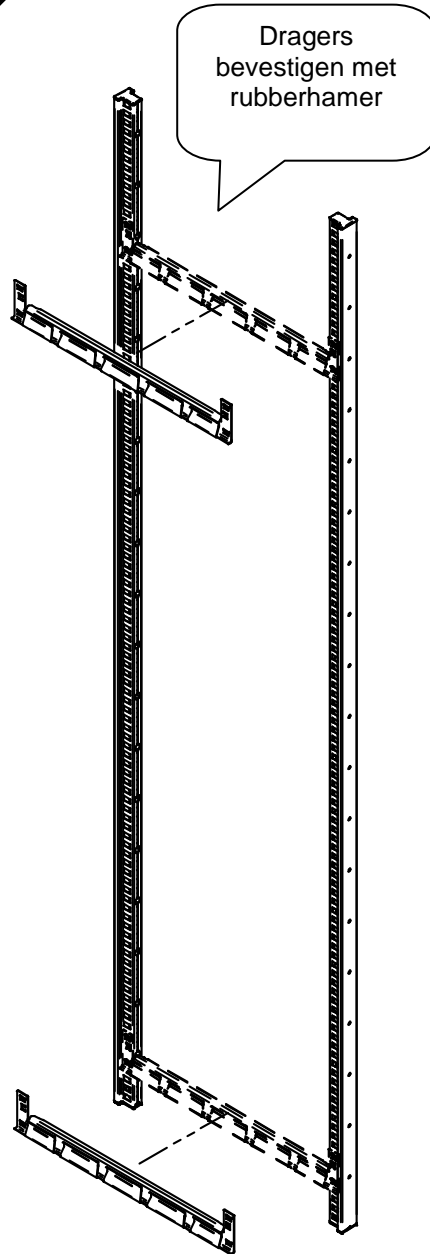

3

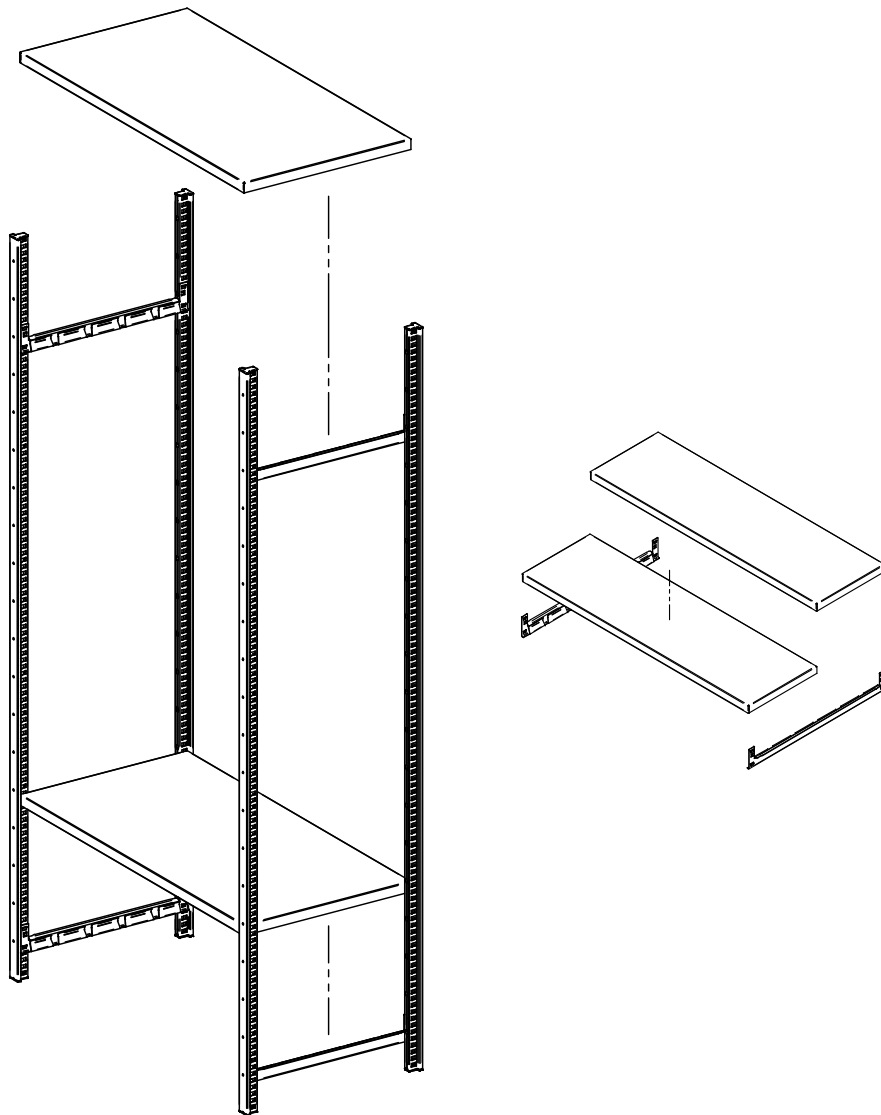

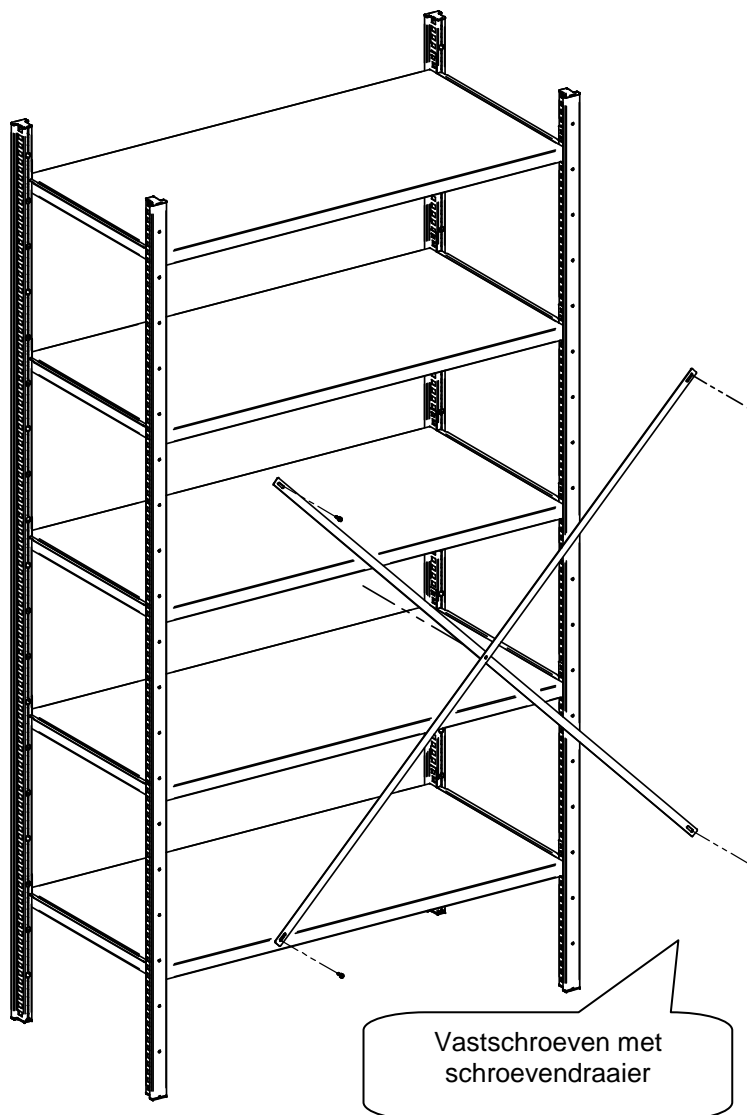

1 kruisschoor per 3 secties

5

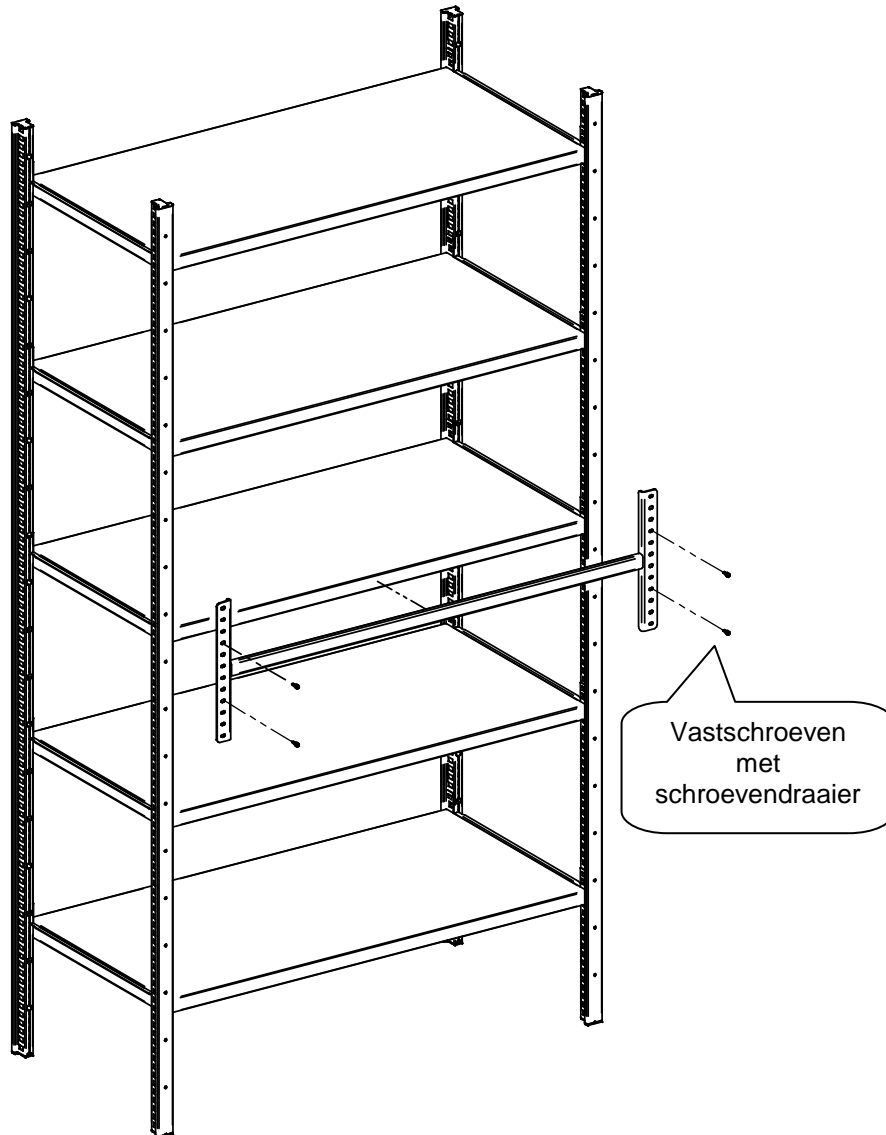

Als alternatief voor kruisschoor, 1 H-schoor per 2 secties monteren

6

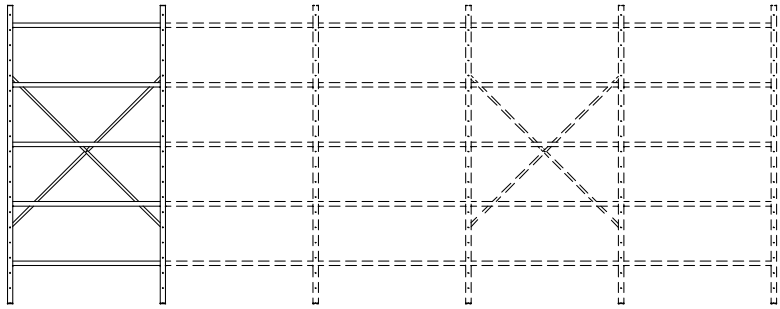
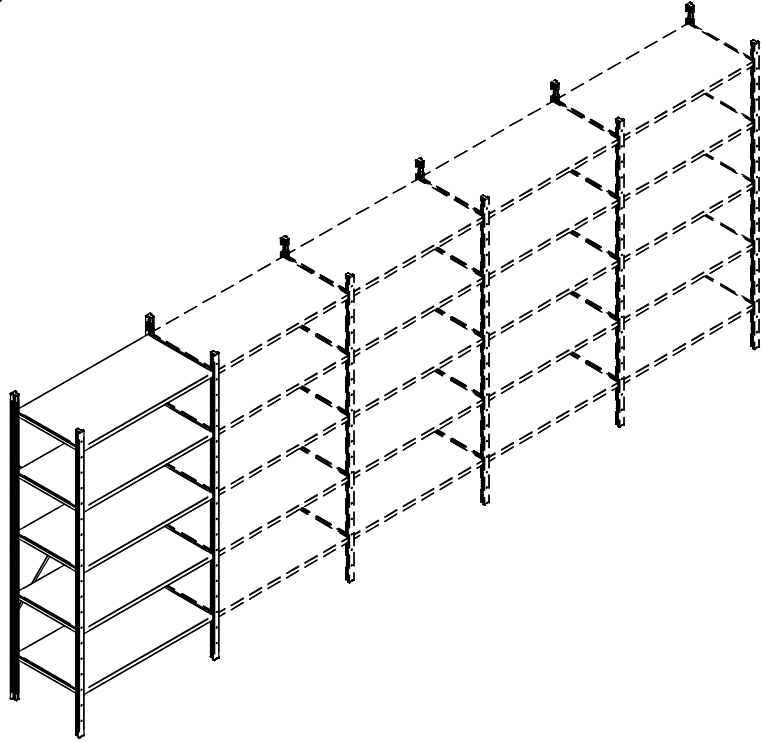

7

Optioneel aan een muur te bevestigen door middel van muurbeugels

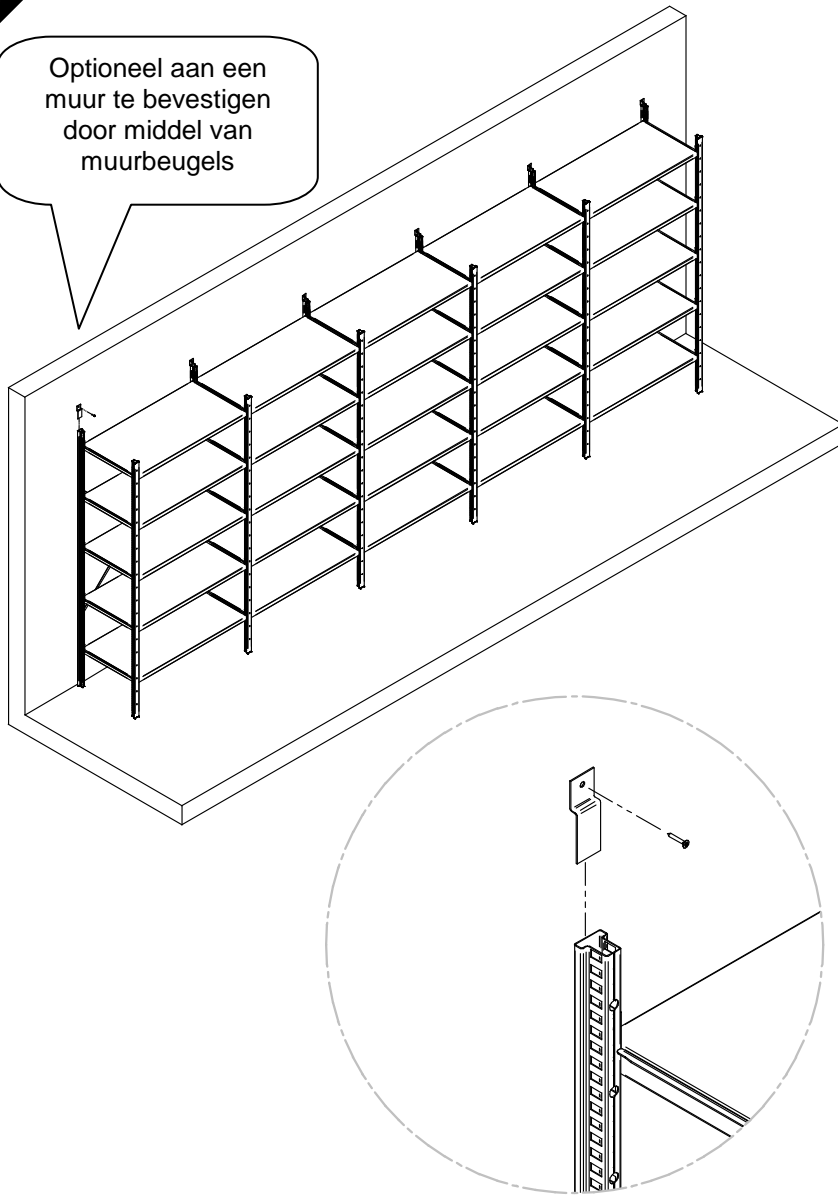

8

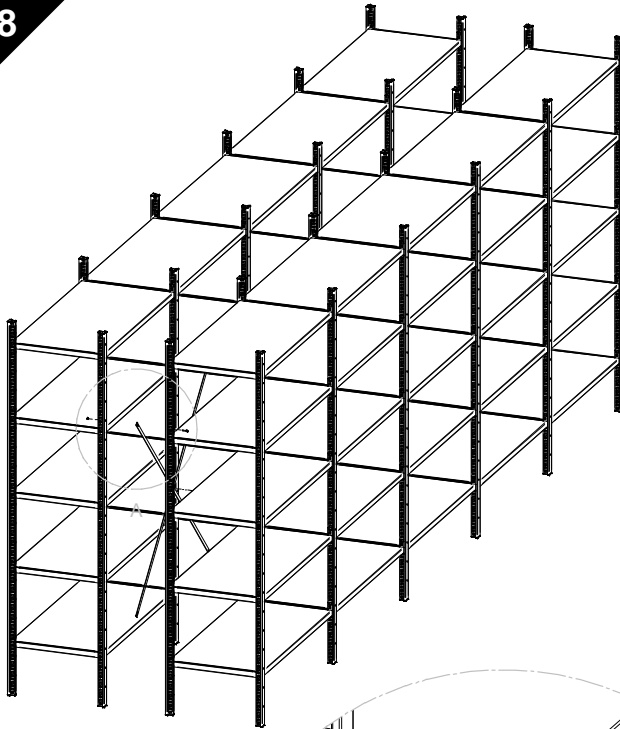

Bij rugmontage,
stellingen koppelen
met inbusbout.

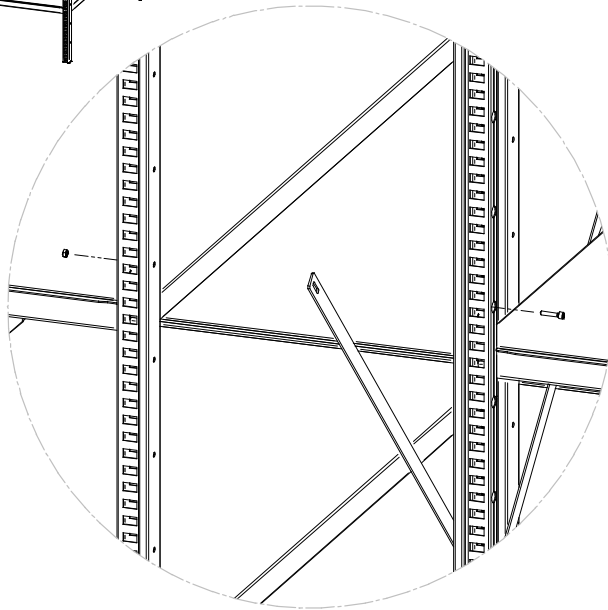

Toelaatbare belasting (GELIJKMATIG VERDEELD)

Legbord (lxb)	Draagvermogen [kg]
550 x 200 mm	140
550 x 300 mm	120
550 x 400 mm	120
850 x 200 mm	110
850 x 300 mm	100
850 x 400 mm	100
1.000 x 100 mm	100
1.000 x 200 mm	100
1.000 x 300 mm	90
1.000 x 400 mm	90
1.000 x 500 mm	70
1.150 x 200 mm	90
1.150 x 300 mm	70
1.300 x 200 mm	70
1.300 x 300 mm	50

Diverse samenstellingen

Voorbeeld 1:

Afmeting:
Samenstelling:
Maximale belasting:(1x70kg) 70 kg

1000x500
1 x legbord 1000x500

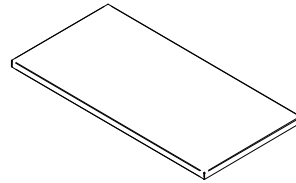

Voorbeeld 2:

Afmeting:
Samenstelling:
Maximale belasting:(1x90kg + 1x100kg)
190 kg

1000x500
1 x legbord 1000x300
1 x legbord 1000x200

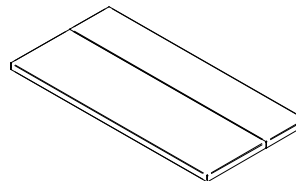

Voorbeeld 3:

Afmeting:
Samenstelling:
Maximale belasting:(5x100kg) 500 kg

1000x500
5 x legbord 1000x100

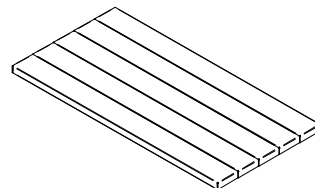

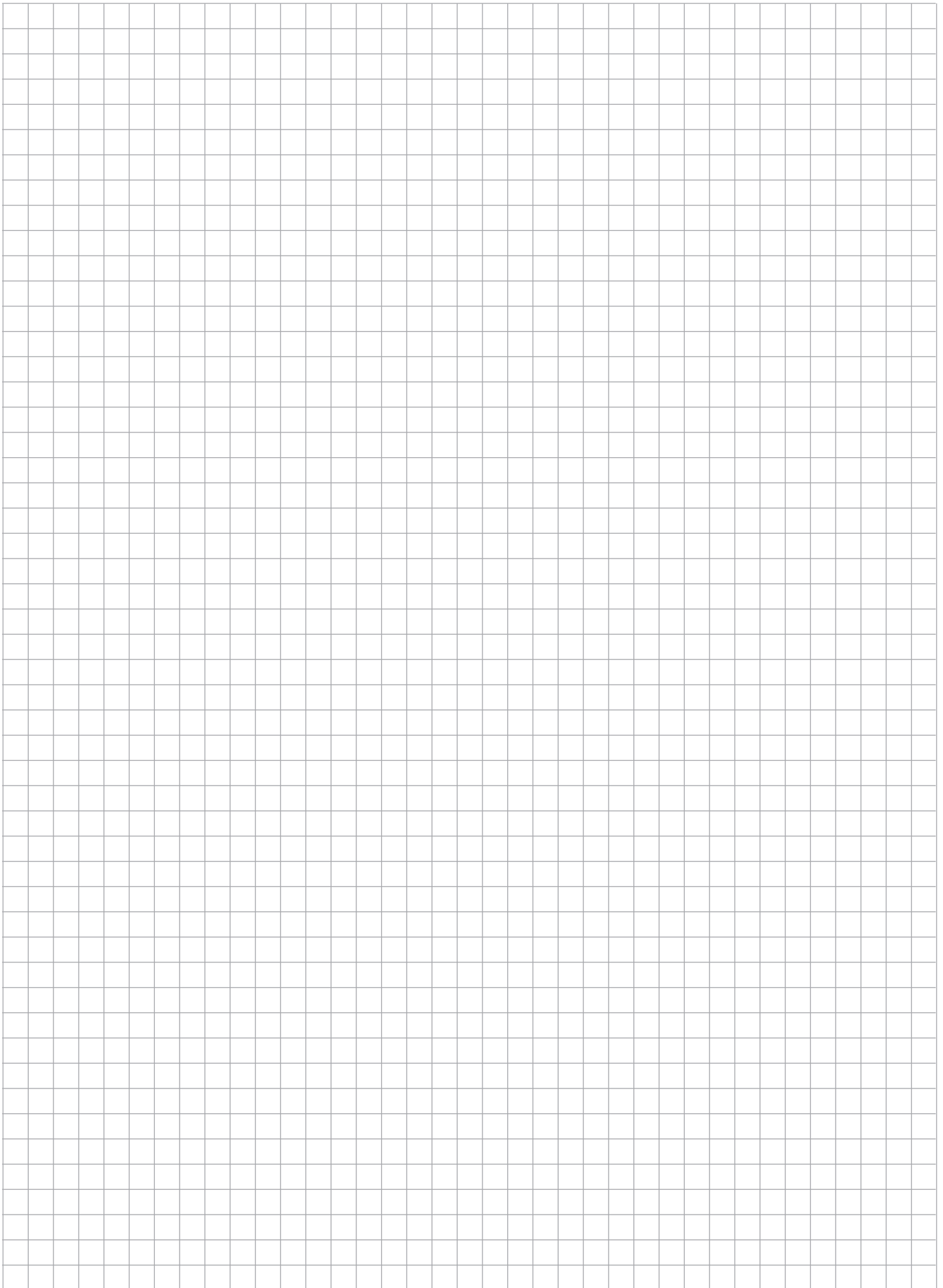



Ijsselstraat 9-13 \ 5347 KG Oss \ The Netherlands \ T +31 (0)412 667650 \ E info@begra.nl \ www.begra.nl
[Iban](#) NL80 RABO 0146 3423 21 \ [KvK](#) Oost Brabant 17207142 \ [BTW](#) 8180.3852.4B01