

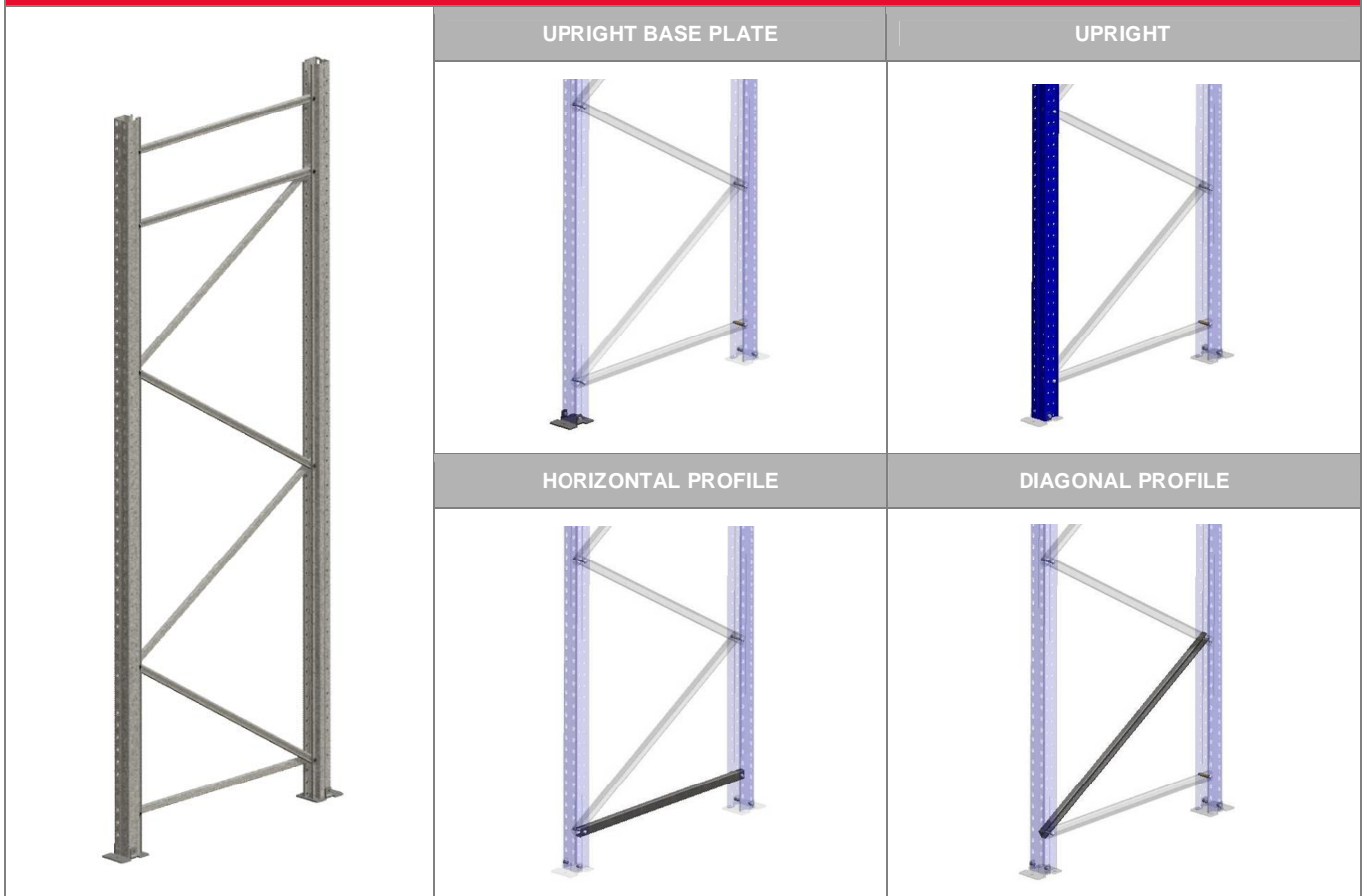

# montage handleiding

Frames AR T2 palletstellingen - M

## FRAME M



DESCRIPTION	A vertical structure consisting of 2 uprights, joined by a system of bracing profiles, and base plates intended to support the storage levels.		
DIMENSIONS AND COMPONENTS	An M frame consists of two M uprights and their corresponding bracing profiles, upright base plates and fixing elements (bolts, nuts and bushings).		
DESIGNATION	FRAME [UPRIGHT MODEL]/[DEPTH]/[HEIGHT]/[FINISH]		
MATERIAL	UPRIGHT MODEL	M1	
	TYPE OF BASEPLATE 3 alternatives:	P	Base plate BP80/E000. See datasheet FT-001007 · ZINC finish in all cases
		S	Base plate BGABS080AZAR. See datasheet FT-001025 · AZAR finish for pregalvanised uprights · Same finish as for M upright in other cases
		0	No upright base plate
	DEPTH	<b>Bt</b> : Distance between Upright Face Widths Diagonal bracing (D600) is made using C3015 profiles with M1020 perforation. See datasheet FT-003439	
	HEIGHT	<b>L</b> : Length of Upright M	
FINISH	Based on finish of Upright M		

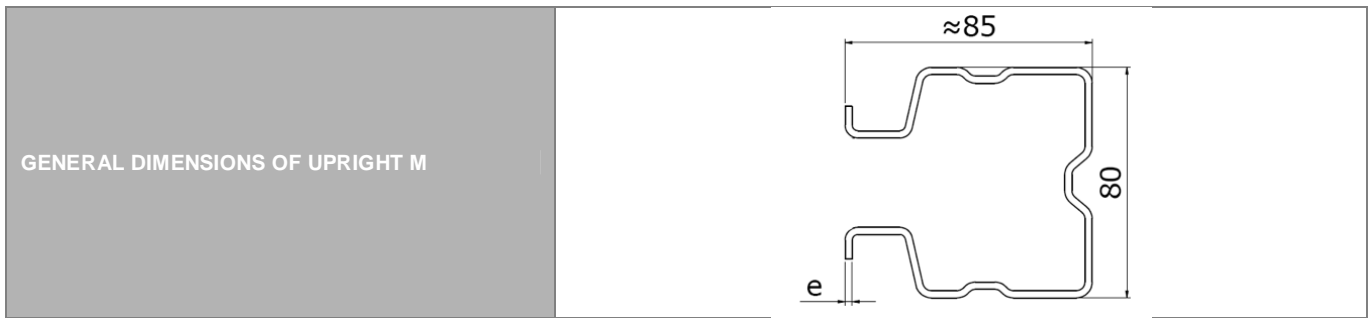

FRAME DIMENSIONS BASED ON THE UPRIGHT BASE PLATE USED		
No base plate: 0	Base plate BP80/E000: P	Base plate BS01/080AZAR: S
	$B_t + 2 \times 56 = B_t + 112$ 	$B_t + 2 \times 17 = B_t + 34$ 

Bracing consists of C30x15 horizontal and diagonal profiles whose length, based on the depth of the M frame, is shown in the following table:

FRAME DEPTH $B_t$ (mm)	LENGTH OF HORIZONTAL $L_h$ (mm)	LENGTH OF DIAGONAL $L_d$ (mm)	
600	492	791	
700	592	855	
800	692	926	
900	792	1002	
1000	892	1082	
1100	992	1165	
1200	1092	1251	
1300	1192	1339	

To calculate the length of horizontal and diagonal profiles of frames, the following equation can be used:

Length of horizontal profile: $L_h = L_{horizontal} = B_t - 108$	Length of diagonal profile: $L_d = L_{diagonal} = \sqrt{(L_h - 40)^2 + (600)^2} + 40$
---	--

**FRAME ASSEMBLY: D600 diagonal bracing of horizontal and diagonal profiles. Dimensions to centrelines of axes**

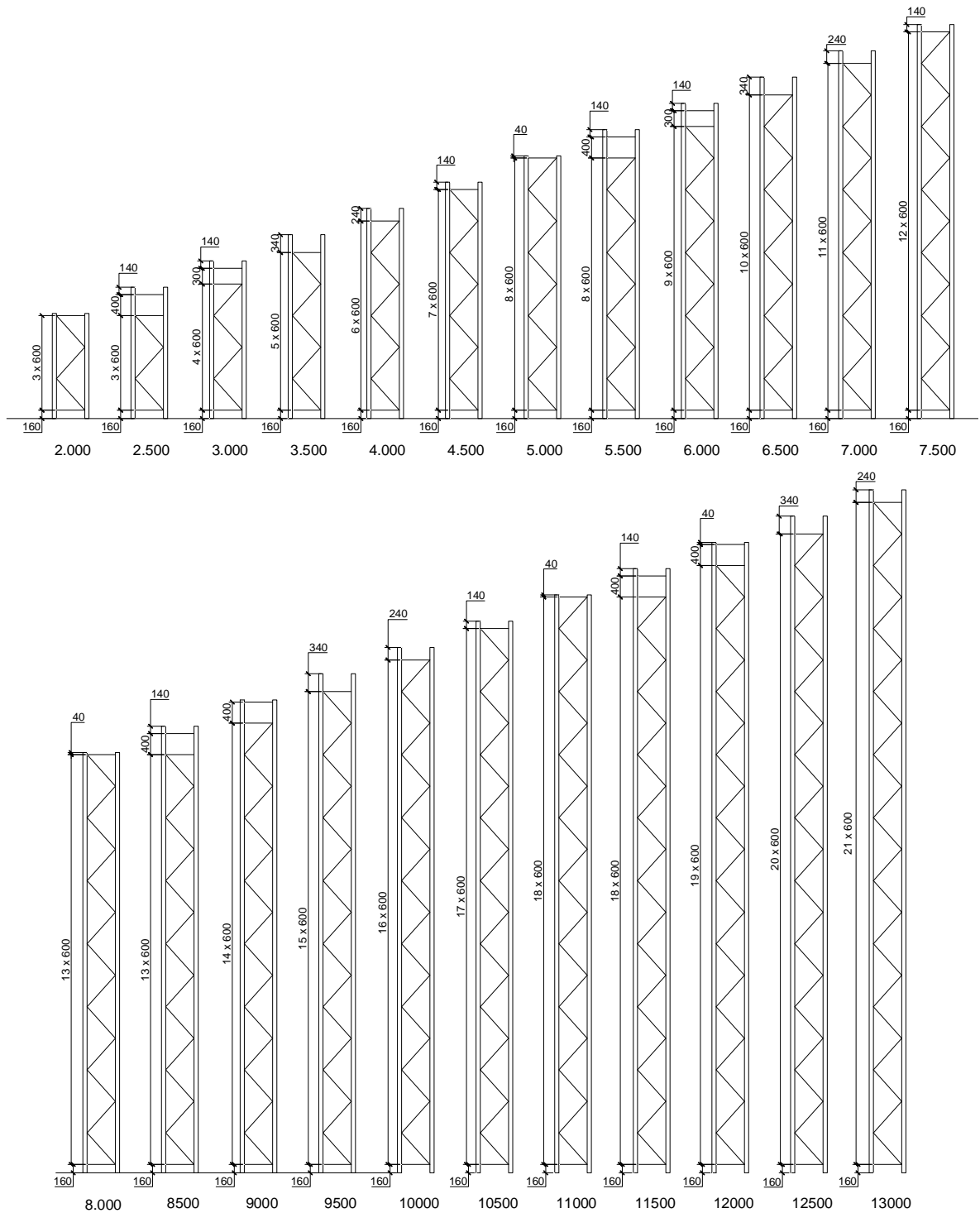



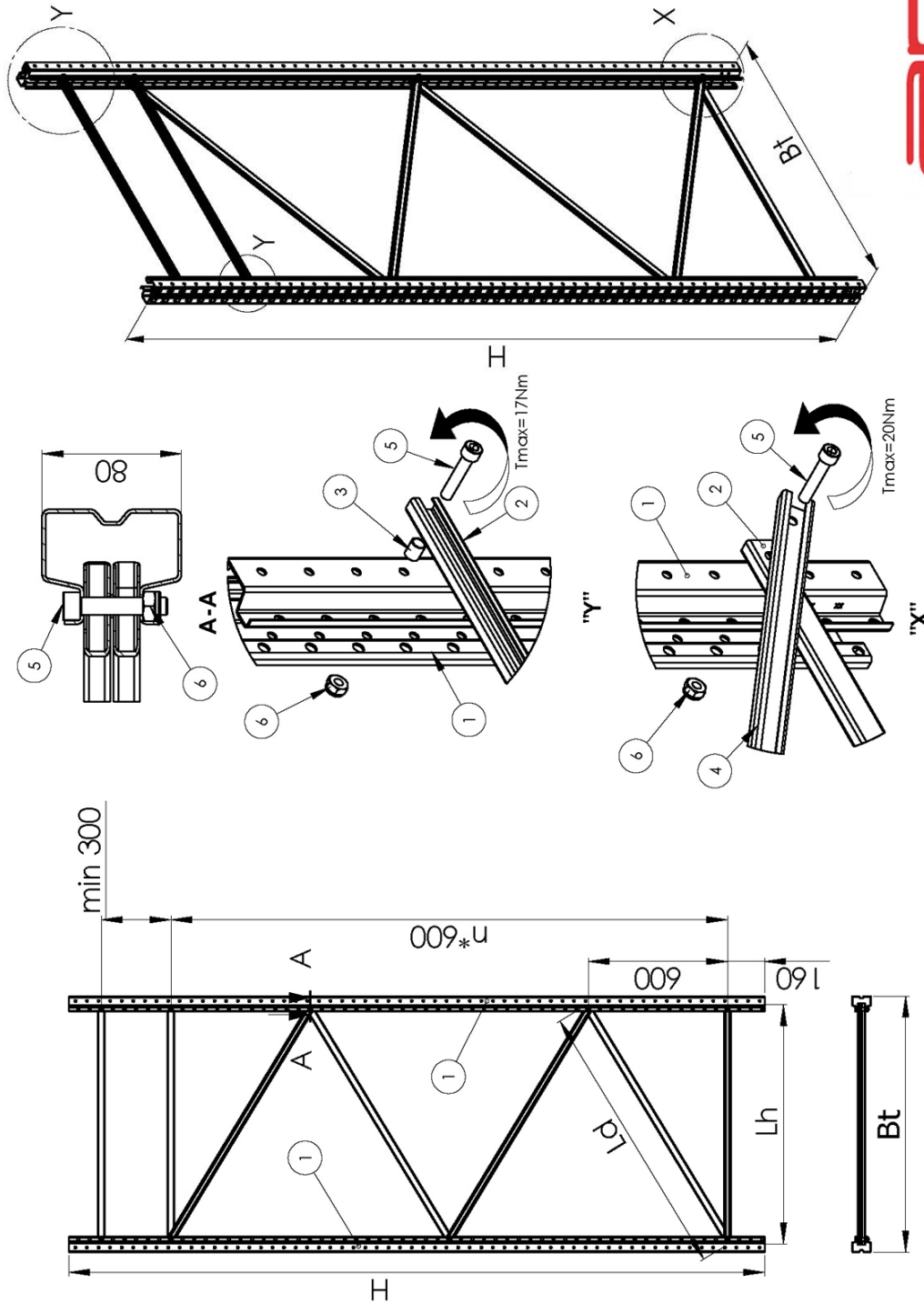

The first horizontal profile is placed 160 mm from the base plate and then diagonal profiles are placed in 600 mm pitch, with a final horizontal profile. If the distance of the last horizontal profile at the end of the upright is equal to or greater than 440, another horizontal profile will be placed at a minimum distance of 300 mm. The following figures show the different configurations depending on the frame height.

Please note the torque of C3015 profiles in order to avoid deformations during assembly (see ASSEMBLY INSTRUCTIONS).

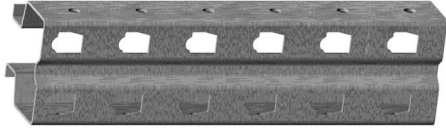
ASSEMBLY INSTRUCTIONS

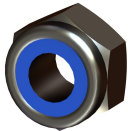

COMPONENTS AND QUANTITIES		
MARK	ELEMENT	
1	UPRIGHT M	
2	PROFILE 3015 Length Lh	
3	SPACER CAD11/15/Z	
4	PROFILE 3015 Length Ld	
5	BOLT BO-M10X50/D912/8.8/Z000	
6	NUT NU-M10/D985/8/Z000	

There are 3 alternatives for setting up the frame depending on the base plate used:

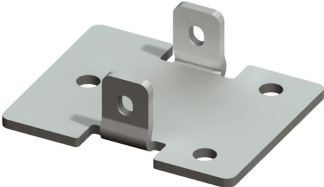
BASE PLATE P	Joined to upright using:	
	QUANTITY	DESIGNATION
	2	BOLT BO-M8X20/D933/8.8/Z000
	2	NUT NU-M8/D985/8/Z000

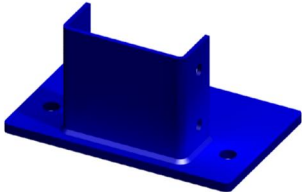
BASE PLATE S	Joined to upright using:	
	QUANTITY	DESIGNATION
	4	BOLT BO-M8X20/D933/8.8/Z000
	4	NUT NU-M8/D985/8/Z000

NO BASE PLATE	

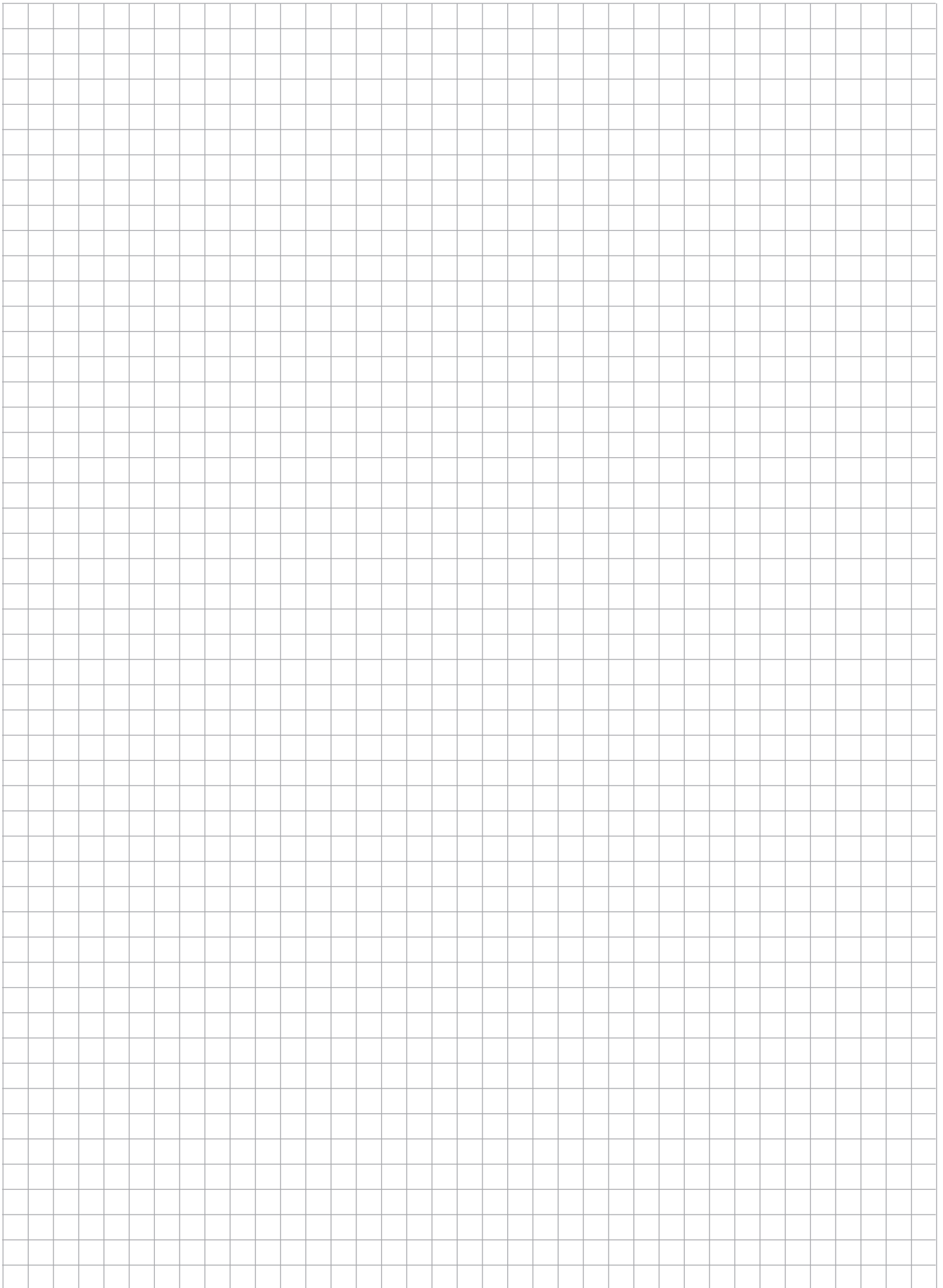



Ijsselstraat 9-13 \ 5347 KG Oss \ The Netherlands \ T +31 (0)412 667650 \ E [info@begra.nl](mailto:info@begra.nl) \ [www.begra.nl](http://www.begra.nl)  
[Iban](#) NL80 RABO 0146 3423 21 \ [KvK](#) Oost Brabant 17207142 \ [BTW](#) 8180.3852.4B01