



Assembly Instructions
Light Duty BR Cantilever Racking
Type: CRL-BR25



Oversized Storage Solutions

Assembly Instructions CRL-BR25

Step 1. Uprights + Baseconnection

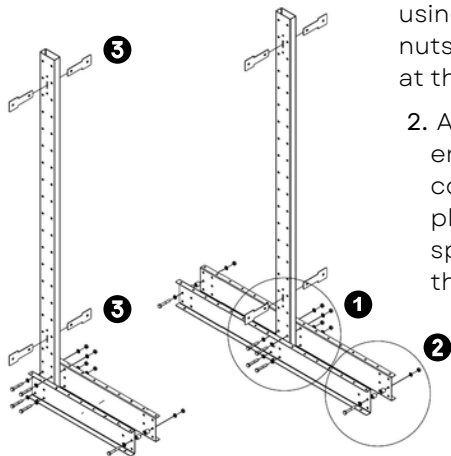

1. Place the column in a vertical position first, and attach the base using four hex bolts, washers and nuts in the corresponding holes at the bottom of the upright.

2. Attach a hex bolt and nut at the end of each base to firmly connect the two baseparts, and place the supplied black plastic spacers (tube profile) between the two base sections.

3. Attach the bracing plates and approach the upright simultaneously in the side sleeves on the right en left side. Two plates in the upper sleeve, and two in the lower sleeve.

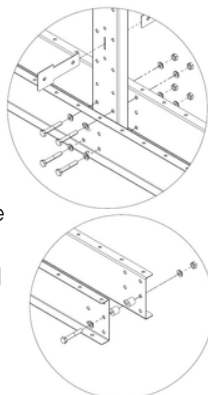





			
DIN931/8.8	DIN934/8	DIN125A	
M10X65	M10	Ø 11	PE 20X20X10,2

Step 2. Attach bracing

4. Assemble two horizontal bracings and connect them to the front side of both the upper and lower bracing plates using hex socket bolts, washers, and nuts. At the same time, assemble a diagonal bracing on the back side of the same bracing plates, using the same holes. Where the diagonal bracing interferes with the horizontal bracing, use fender washers instead of standard washers.

5. Assemble the same set of bracings every second bay, each time in opposite direction in order to create stiffness in the setup.

			
DIN912/8.8	DIN934/8	DIN125A	DIN9021
M10X25	M10	Ø 11	Ø 11

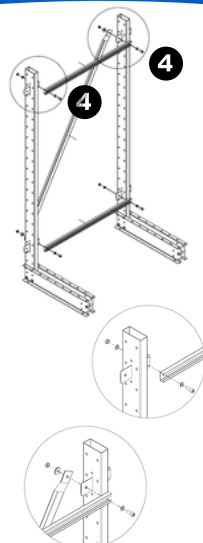

Assembly Instructions CRL-BR25

Step 3. Connecting the arms



6. The same applies to both standard arms and box-section arms: start by attaching the arm to the column at the desired height using a hex bolt, washer and a nut. Do not tighten it fully yet. First, vertically lift the arm slightly and at the same time insert the zinc coated pressure plate between arm and upright. Then tighten the bolt and nut further.

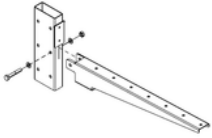

7. Optionally, separation pins and a protection plate can be added on the corresponding holes on the top side of the arm. Attach the nut to fix.



8. In the case of the box-section arm, a plastic end cap must also be fitted. Press it into place.

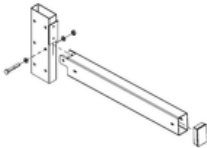

DIN931/8.8	DIN934/8	DIN125A
M10X65	M10	Ø 11

	R10-75 M8
	M8 I DIN6923/8

Step 4. Optional: Add shelves

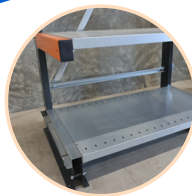

9. Place the omega profile at the base and secure it with self-drilling screws in the small corresponding holes. Use the clips at the arms; these can be fixed in place with a snapping motion. In both cases, a shelf can then be placed on top, where it will rest securely.

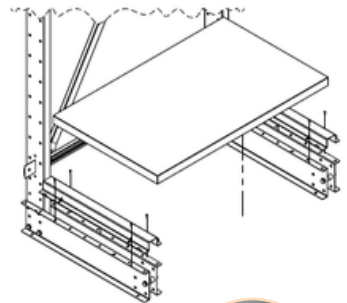

DIN7504N
3,5X16



Assembly Instructions CRL-BR25

Step 5. Anchor the setup



10. Ensure that the structure is perfectly vertical and that the bases are aligned right-angled. Use a spirit level for this.

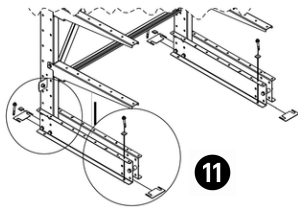

11. If the surface on which the racks are placed is not completely level, shims can be added to the front and rear of the base (and also in the middle when double sided) to ensure the structure is perfectly aligned and level.

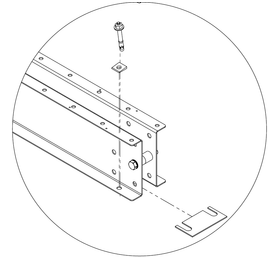

12. After the racks are completely level, they can be anchored. Not in every hole: Do this following the pattern indicated with the red dots indicated in the top view, below. Secure the anchors at a slight angle, as shown on the right and make sure angled plates are placed between the anchor and base profile.

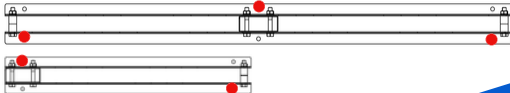

	M8x65
	8% I M8 DIN435

Finished

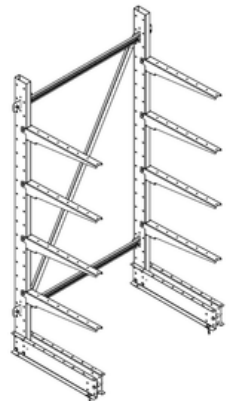

You're all set. If everything is correct, the rack should now be perfectly aligned and ready to be loaded. We hope you'll enjoy using it for many years to come. Best of luck with your business!

P.s. Still have questions? Your BR Dealer is ready to support you!